







The **SPECTRUM** hallway is simple to plan with by adding on the extension columns and it provides many different possibilities.

- **Various single units** in 4 heights, which can be combined at will
- **Clothes units** for fitting on wall, with hat rack, clothes rod and bag hooks
- **Clothes mirrors** in 3 widths and 4 heights
- **Comprehensive accessories:** pull-out clothes rod, clothes hangers, umbrella stand, utensil basket, wall shelves
- **IMPORTANT NOTE!** The single units offered in this list are only to be viewed as suggestions and can only show an excerpt from the many possible arrangements. Furthermore, you can also choose different combinations from the individual ranges (see the "Ideas for living" price list).

## Knob/handle assortment

You can choose from a variety of knobs/handles. Please state the corresponding knob/handle number. If no details are given in the order, knob 20 is supplied. Doors with aluminium frame and mirror panel have a standard aluminium-coloured handle.



Knob	Type no.	Knob	Type no.
	20		50
wooden surface		solid steel look	
	30		80
wooden surface on solid steel base		solid steel look	
	40		
aluminium colour			

## List of versions







Model no.	Front and carcase	Price group
144	White lacquer	I
149	Beech	I
146	Natural maple	II

**Important notes:** Fittings for wall mounting are provided with nearly all the units which should be used for your own safety and for constructional reasons. The assembly materials supplied by hülsta (plugs, screws) are only suitable for fitting components on to concrete and/or solid walls. Ideally, one should inquire about the soundness of the walls with regard to their suitability for mounting units when orders are placed and be sure to check them later before mounting any units. If any surfaces are not suitable for mounting units (e.g. plastered or lighter wall materials), one should use another method better suited to the material on site.

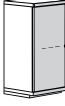





- **hülsta-SoftFlow:** All drawers on hidden bearings with auto pull-in feature with brake
- **hülsta-MagicClose:** All wooden hinge-doors with door hinge brake
- Max. load of (fitted) wooden shelves and drawers: 25 kg
- All units up to 7 Raster height with knob, from 8 Raster height with rod lock

<p><b>2 Raster extension columns</b> 43.8 cm high (incl. 5.4 cm high plinth); 37 cm deep incl. top cover, 2.9 cm thick Accessories see page 45</p>		2 drawers  40 cm wide	2 drawers  60 cm wide	2 drawers  80 cm wide	
	Depth:	37 cm	37 cm	37 cm	
	Price gr. I II	<b>D24310</b> - -	<b>D26310</b> - -	<b>D28310</b> - -	

**4 Raster extension columns**

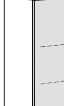
<p><b>4 Raster extension columns</b> 82.2 cm high (incl. 5.4 cm high plinth); 37 cm deep (shoe cupboard 24.1 cm deep) incl. top cover, 2.9 cm thick <b>Interior fittings:</b> Fitted wooden shelves are included ex-works behind wooden doors at intervals of 2 Rasters. <b>Shoe cupboard</b> with 2 flap compartments incl. shoe baskets (chrome) Accessories see page 45</p>		1 wooden door  L 40 cm wide	2 wooden doors  60 cm wide	2 wooden doors  80 cm wide	
	Depth:	37 cm	37 cm	37 cm	
	Price gr. I II	<b>D443310 L</b> <b>D443320 R</b> - -	<b>D46330</b> - -	<b>D48330</b> - -	
		4 drawers  40 cm wide	4 drawers  60 cm wide	4 drawers  80 cm wide	<b>Shoe cupboard</b>  80 cm wide
	Depth:	37 cm	37 cm	37 cm	24.1 cm
	Price gr. I II	<b>D44310</b> - -	<b>D46310</b> - -	<b>D48310</b> - -	<b>D48320</b> - -

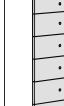
**6 Raster extension columns**

<p><b>6 Raster extension columns</b> 120.6 cm high (incl. 5.4 cm high plinth); 37 cm deep (shoe cupboard 24.1 cm deep) incl. top cover, 2.9 cm thick <b>Interior fittings:</b> Fitted wooden shelves are included ex-works behind wooden doors at intervals of 2 Rasters. <b>Shoe cupboard</b> with 3 flap compartments incl. shoe baskets (chrome) Accessories see page 45</p>		1 wooden door  L 40 cm wide	2 wooden doors  60 cm wide	2 wooden doors  80 cm wide	
	Depth:	37 cm	37 cm	37 cm	
	Price gr. I II	<b>D643310 L</b> <b>D643320 R</b> - -	<b>D66330</b> - -	<b>D68330</b> - -	
		6 drawers  40 cm wide	6 drawers  60 cm wide	6 drawers  80 cm wide	<b>Shoe cupboard</b>  80 cm wide
	Depth:	37 cm	37 cm	37 cm	24.1 cm
	Price gr. I II	<b>D64310</b> - -	<b>D66310</b> - -	<b>D68310</b> - -	<b>D68320</b> - -

# SPECTRUM 11 Raster extension columns

List of versions: see page 40

**11 Raster extension columns**  
216.6 cm high (incl. 5.4 cm high plinth); 37 cm deep (shoe cupboard 24.1 cm deep)

incl. top cover, 2.9 cm thick







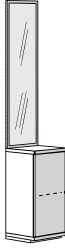
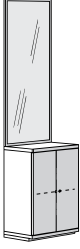
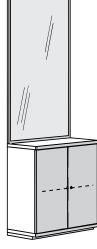
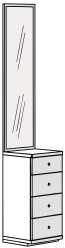
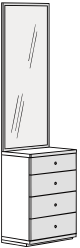

**Interior fittings:**  
Fitted wooden shelves are included ex-works behind wooden doors at intervals of 2 Rasters.

Mirrors with all-round aluminium frame

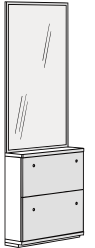
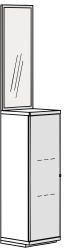
**Change of versions:**  
For extension columns, the entire front section or the cover shelf can also be ordered in a different version. Please clearly mark the altered versions in the sketch. When versions from a different price group are exchanged, the higher price group is charged.

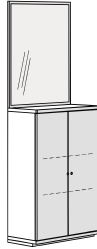
**Shoe cupboard**  
with 2 or 3 flap compartments incl. shoe baskets (chrome)

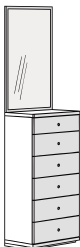
Accessories see page 45

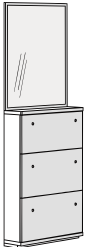
	Mirror; 1 wooden door  40 cm wide <b>L</b>	Mirror; 2 wooden doors  60 cm wide	Mirror; 2 wooden doors  80 cm wide	
Depth:	37 cm	37 cm	37 cm	
Price gr. I II	<b>D143011 L</b> <b>D143012 R</b> - -	<b>D16301</b> - -	<b>D18301</b> - -	
	Mirror; 4 drawers  40 cm wide	Mirror; 4 drawers  60 cm wide	Mirror; 4 drawers  80 cm wide	Mirror; shoe cupboard  80 cm wide
Depth:	37 cm	37 cm	37 cm	24.1 cm
Price gr. I II	<b>D14302</b> - -	<b>D16302</b> - -	<b>D18302</b> - -	<b>D18303</b> - -
	Mirror; 1 wooden door  40 cm wide <b>L</b>	Mirror; 2 wooden doors  60 cm wide	Mirror; 2 wooden doors  80 cm wide	
Depth:	37 cm	37 cm	37 cm	
Price gr. I II	<b>D143041 L</b> <b>D143042 R</b> - -	<b>D16304</b> - -	<b>D18304</b> - -	
	Mirror; 6 drawers  40 cm wide	Mirror; 6 drawers  60 cm wide	Mirror; 6 drawers  80 cm wide	Mirror; shoe cupboard  80 cm wide
Depth:	37 cm	37 cm	37 cm	24.1 cm
Price gr. I II	<b>D14305</b> - -	<b>D16305</b> - -	<b>D18305</b> - -	<b>D18306</b> - -

**11 Raster extension columns**  
 216.6 cm high  
 (incl. 5.4 cm high plinth);  
 37 cm deep

incl. top cover,  
 2.9 cm thick

**Interior fittings:**

Fitted wooden shelves are included ex-works behind wooden doors or doors with aluminium frame and mirror panel at intervals of 2 Rasters.

Doors with aluminium frame and mirror panel with standard aluminium-coloured handle.

Mirrors with all-round aluminium frame







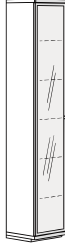
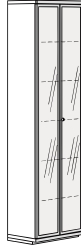
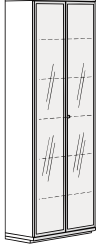

**Change of versions:**

For extension columns, the entire front section or the cover shelf can also be ordered in a different version.

Please clearly mark the altered versions in the sketch.

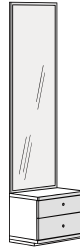
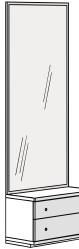

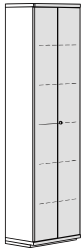
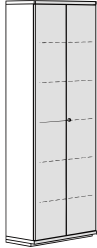
When versions from a different price group are exchanged, the higher price group is charged.

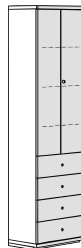
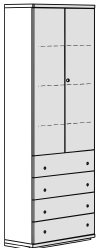
Accessories see page 45





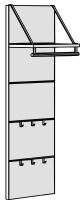
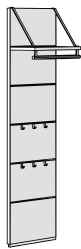
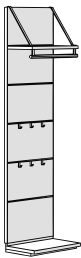
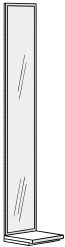

	1 mirror door  40 cm wide L	2 mirror doors  60 cm wide	2 mirror doors  80 cm wide		
Depth:	37 cm	37 cm	37 cm		
Price gr. I II	D143071 L D143072 R - -	D16307 - -	D18307 - -		
	1 wooden door; 2 drawers  40 cm wide L	2 wooden doors; 2 drawers  60 cm wide	2 wooden doors; 2 drawers  80 cm wide	Mirror; 2 drawers  60 cm wide L	Mirror; 2 drawers  80 cm wide L
Depth:	37 cm	37 cm	37 cm	37 cm	37 cm
Price gr. I II	D143081 L D143082 R - -	D16308 - -	D18308 - -	D16309 - -	D18309 - -
	1 wooden door  40 cm wide L	2 wooden doors  60 cm wide	2 wooden doors  80 cm wide		
Depth:	37 cm	37 cm	37 cm		
Price gr. I II	D143101 L D143102 R - -	D16310 - -	D18310 - -		
	1 wooden door; 4 drawers  40 cm wide L	2 wooden doors; 4 drawers  60 cm wide	2 wooden doors; 4 drawers  80 cm wide		
Depth:	37 cm	37 cm	37 cm		
Price gr. I II	D143111 L D143112 R - -	D16311 - -	D18311 - -		



# SPECTRUM 9 and 11 Raster extension columns

List of versions: see page 40









<p><b>9 and 11 Raster clothes panels</b> 172.8; 211.2 or 216.6 cm high 3.8 cm thick; 37 cm deep incl. hat rack/plinth shelf (plinth shelf 5.4 cm high)</p> <p>with hat rack, clothes rod and 6 bag hooks (aluminium-coloured, powder-coated)</p> <p>Clothes panel with aluminium profile left and right</p>	<p>Clothes panel, 172.8 cm high (for fitting above 2 Raster extension columns)</p>  <p>60 cm wide</p>		<p>Clothes panel, 211.2 cm high (for fitting anywhere on wall 5.4 cm above floor)</p>  <p>60 cm wide</p>		<p>Clothes panel incl. plinth shelf, 216.6 cm high</p>  <p>60 cm wide</p>		
	Depth:	37 cm	37 cm	37 cm	37 cm	37 cm	
	Price gr. I II	<b>DP96</b> - -	<b>DP116</b> - -	<b>DP1160</b> - -	<b>DP1160</b> - -	<b>DP1160</b> - -	
<p><b>11 Raster mirrors with plinth shelf</b> 216.6 cm high 2.0 cm thick; incl. 5.4 cm high plinth shelf, 37.0 cm deep</p> <p>Mirrors with all-round aluminium frame</p>	<p>Mirror incl. plinth shelf</p>  <p>40 cm wide</p>			<p>Mirror incl. plinth shelf</p>  <p>60 cm wide</p>			
	Depth:	37 cm			37 cm		
	Price gr. I II	<b>DS1140</b> - -			<b>DS1160</b> - -		

## Mirrors

<p><b>Mirrors</b> 2.0 cm thick Mirrors with all-round aluminium frame for fitting anywhere on wall</p>	 <p>96 x 40 cm</p>		 <p>96 x 60 cm</p>		 <p>96 x 80 cm</p>		 <p>134.4 x 40 cm</p>		 <p>134.4 x 60 cm</p>		 <p>134.4 x 80 cm</p>	
	Price gr. I II	<b>DS54</b> - -	<b>DS56</b> - -	<b>DS58</b> - -	<b>DS74</b> - -	<b>DS76</b> - -	<b>DS78</b> - -	<b>DS74</b> - -	<b>DS76</b> - -	<b>DS78</b> - -	<b>DS74</b> - -	<b>DS76</b> - -
	Price gr. I II			<b>DS96</b> - -		<b>DS98</b> - -		for fitting 5.4 cm above floor <b>DS114</b> - -		for fitting 5.4 cm above floor <b>DS116</b> - -		

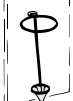
<b>Wall shelves</b> 2.9 cm thick; 18.0 cm deep  for fitting anywhere on wall; special invisible, adjustable bracket				
		40 cm wide	60 cm wide	80 cm wide
	<b>Price gr.</b>	<b>4018</b>	<b>6018</b>	<b>8018</b>
	I	-	-	-
	II	-	-	-

## Accessories for extension columns

		for 40 cm width	for 60 cm width	for 80 cm width
	<b>Fitted wooden shelves</b> 2.0 cm thick; 35.0 cm deep for fitting anywhere in extension columns	<b>0437</b>	<b>0637</b>	<b>0837</b>
		-	-	-
	<b>Fitted glass shelves</b> <b>(clear glass)</b> 0.8 cm thick; 34.0 cm deep	<b>31643</b>	<b>31663</b>	<b>31683</b>
		-	-	-
	<b>Protective mat</b> (set of 3) of transparent plastic; for drawers and fitted shelves	<b>943</b>	<b>963</b>	<b>983</b>
		-	-	-
	<b>Pull-out clothes rod</b>		<b>734</b>	
			-	
	<b>Utensil basket</b> (chrome, is fitted to the inner side of closed extension columns) Height: 10 cm; width: 28 cm; depth: 12 cm		<b>094</b>	
			-	
	<b>Umbrella stand</b> metal, aluminium-coloured; is fitted in connecting rails of clothes panels Height: 30.0 cm; width: 23.4 cm; depth: 23.4 cm		<b>907</b>	
			-	
	<b>Hook</b> metal, aluminium-coloured; is fitted in connecting rails of clothes panels Height: 4.5 cm; width: 1.6 cm		<b>905</b>	
			-	
	<b>Set of drawers</b> with 2 box drawers is fitted in connecting rails of clothes panels Height: 18.1 cm; width: 18.1 cm; depth: 18.1 cm Not available in white lacquer!	<b>Price gr.</b>	<b>906</b>	
		I	-	
		II	-	
	<b>Storage shelf</b> with 2 metal supports is fitted in connecting rails of clothes panels Height: 2.6 cm; width: 18.1 cm; depth: 18.1 cm	<b>Price gr.</b>	<b>908</b>	
		I	-	
		II	-	

As an alternative to putting together your own combination from the entire range, it is possible to choose one of the suggested combinations. This makes planning easier. The suggested combinations can be enhanced by including accessories. These are charged extra.

<p>Price gr. I II</p>	<p><b>D980001</b></p> <p>-</p>	<p><b>D980002</b></p> <p>-</p>
<p>Price gr. I II</p>	<p><b>D980003</b></p> <p>-</p>	<p><b>D980004</b></p> <p>-</p>
<p>Price gr. I II</p>	<p><b>D980005</b></p> <p>-</p>	<p><b>D980006</b></p> <p>-</p>

As an alternative to putting together your own combination from the entire range, it is possible to choose one of the suggested combinations. This makes planning easier. The suggested combinations can be enhanced by including accessories. These are charged extra.

<p><b>Price gr.</b> I II</p>	<p>as illustrated vice versa</p> <p><b>D980007</b> <b>D980207</b></p> <p>-</p>	<p><b>D980008</b></p> <p>-</p>
<p><b>Price gr.</b> I II</p>	<p><b>D980009</b></p> <p>-</p>	<p><b>D980010</b></p> <p>-</p>
<p><b>Price gr.</b> I II</p>	<p><b>D980011</b></p> <p>-</p>	<p><b>D980012</b></p> <p>-</p>